

# FCC Part 15B Test Report

**Report No.** : TB-FCC168745  
**Applicant** : ShenZheng HongRui Optical Technology Co., Ltd.  
**Equipment Under Test (EUT)**  
**EUT Name** : 32-Ports 10/100/1000M Managed PoE Switches  
**Model No.** : HR-AFGM-2444S-400  
**Serial Model No.** : N/A  
**Brand Name** : HRUI  
**Receipt Date** : 2019-09-03  
**Test Date** : 2019-09-04 to 2019-10-09  
**Issue Date** : 2019-10-09  
**Standards** : FCC Part 15:2018 Subpart B (Class A)  
**Conclusions** : **PASS**

In the configuration tested, the EUT complied with the standards specified above  
The EUT technically complies with the FCC requirements

**Test/Witness Engineer** :

*Rebecca*

Rebecca

**Engineer Supervisor** :

*Ivan*

**Engineer Manager** :

*Angela*



This report details the results of the testing carried out on one sample. The results contained in this test report do not relate to other samples of the same product. The manufacturer should ensure that all products in series production are in conformity with the product sample detailed in the report.

---

---

## Contents

<b>CONTENTS.....</b>	<b>2</b>
<b>1. GENERAL INFORMATION.....</b>	<b>4</b>
1.1 Client Information.....	4
1.2 General Description of EUT (Equipment Under Test) .....	4
1.3 Block Diagram Showing The Configuration of System Tested.....	5
1.4 Description of Support Units .....	5
1.5 Description of Test Mode.....	5
1.6 Test standards.....	6
1.7 Test Facility.....	6
1.8 Measurement Uncertainty .....	6
<b>2. TEST SUMMARY.....</b>	<b>7</b>
<b>3. TEST EQUIPMENT USED .....</b>	<b>7</b>
<b>4. LABEL REQUIREMENTS &amp; STATEMENT REQUIREMENTS .....</b>	<b>8</b>
<b>5. CONDUCTED EMISSION TEST .....</b>	<b>9</b>
5.1 Test Standard and Limit.....	9
5.2 Test Setup.....	9
5.3 Test Procedure.....	10
5.4 Test Data.....	10
<b>6. RADIATED EMISSION TEST .....</b>	<b>11</b>
6.1 Test Standard and Limit.....	11
6.2 Test Setup.....	11
6.3 Test Procedure.....	12
6.4 Test Data.....	12
<b>7. PHOTOGRAPHS - CONSTRUCTIONAL DETAILS .....</b>	<b>13</b>
<b>8. PHOTOGRAPHS - TEST SETUP .....</b>	<b>18</b>
<b>ATTACHMENT A--CONDUCTED EMISSION DATA.....</b>	<b>19</b>
<b>ATTACHMENT B--RADIATED EMISSION TEST DATA .....</b>	<b>21</b>

## Revision History

Report No.	Version	Description	Issued Date
TB-FCC168745	Rev.01	Initial issue of report	2019-10-09

# 1. General Information

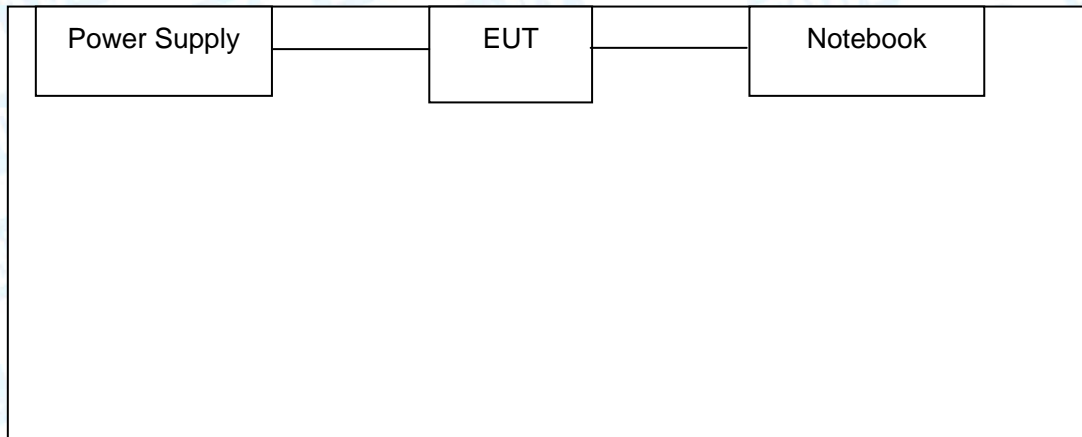
## 1.1 Client Information

Applicant	:	ShenZheng HongRui Optical Technology Co., Ltd.
Address	:	2 Floor, B Building, Shuangjinhui Industrial Park, Yonghe Road, Heping Village, Fuyong Town, Bao'an Dis., Shenzhen, China.
Manufacturer	:	ShenZheng HongRui Optical Technology Co., Ltd.
Address	:	2 Floor, B Building, Shuangjinhui Industrial Park, Yonghe Road, Heping Village, Fuyong Town, Bao'an Dis., Shenzhen, China.

## 1.2 General Description of EUT (Equipment Under Test)

EUT Name	:	32-Ports 10/100/1000M Managed PoE Switches
Model(s)	:	HR-AFGM-2444S-400
Model Difference	:	N/A
Brand Name	:	HRUI
Power Supply	:	Input: 110-264Vac, 50/60Hz Output: 52V 7.69A
Equipment	:	<input checked="" type="checkbox"/> Class A <input type="checkbox"/> Class B
<p><b>Class A Equipment:</b> the Equipment is not intended primarily for use in a residential environment.</p> <p><b>Class B Equipment:</b> the Equipment is intended primarily for use in a residential environment.</p>		

### 1.3 Block Diagram Showing The Configuration of System Tested



Control Room

### 1.4 Description of Support Units

Equipment Information				
Name	Model	S/N	Manufacturer	Used “√”
Notebook	161301-CN	15987/00203076	Xiaomi	√

### 1.5 Description of Test Mode

To investigate the maximum EMI emission characteristics generates from EUT, the test system was pre-scanning tested base on the consideration of following EUT operation mode or test configuration mode which possible have effect on EMI emission level. Each of these EUT operation mode(s) or test configuration mode(s) mentioned follow was evaluated respectively.

For Conducted Test	
Final Test Mode	Description
Mode 1	Normal Mode
For Radiated Test	
Final Test Mode	Description
Mode 1	Normal Mode

## 1.6 Test standards

The objective is to determine compliance with FCC Part 15, Subpart B, and section 15.107, 15.109 rules.

Maintenance of compliance is the responsibility of the manufacturer. Any modification of the product, which result in lowering the emission, should be checked to ensure compliance has been maintained.

## 1.7 Test Facility

The testing report were performed by the Shenzhen Toby Technology Co., Ltd., in their facilities located at 1A/F., Bldg.6, Yusheng Industrial Zone, The National Road No.107 Xixiang Section 467, Xixiang, Bao'an, Shenzhen, Guangdong, China. At the time of testing, the following bodies accredited the Laboratory:

### **CNAS (L5813)**

The Laboratory has been accredited by CNAS to ISO/IEC 17025: 2005 General Requirements for the Competence of Testing and Calibration Laboratories for the competence in the field of testing. And the Registration No.: CNAS L5813.

### **A2LA Certificate No.: 4750.01**

The laboratory has been accredited by American Association for Laboratory Accreditation(A2LA) to ISO/IEC 17025: 2005 General Requirements for the Competence of Testing and Calibration Laboratories for the technical competence in the field of Electrical Testing. And the A2LA Certificate No.: 4750.01.

### **IC Registration No.: (11950A-1)**

The Laboratory has been registered by Certification and Engineering Bureau of Industry Canada for radio equipment testing. The site registration: Site# 11950A-1.

## 1.8 Measurement Uncertainty

The reported uncertainty of measurement  $y \pm U$ , where expanded uncertainty  $U$  is based on a standard uncertainty multiplied by a coverage factor of  $k=2$ , providing a level of confidence of approximately 95 %.

Test	Parameters	Expanded Uncertainty ( $U_{Lab}$ )	Expanded Uncertainty ( $U_{Cispr}$ )
Conducted Emission	Level Accuracy: 9kHz~150kHz 150kHz to 30MHz	$\pm 3.42$ dB $\pm 3.42$ dB	$\pm 4.0$ dB $\pm 3.6$ dB
Radiated Emission	Level Accuracy: Above 1000MHz	$\pm 4.20$ dB	N/A
Radiated Emission	Level Accuracy: 30MHz to 1000 MHz	$\pm 4.40$ dB	$\pm 5.2$ dB

## 2. Test Summary

Test Items	Test Requirement	Test Method	Result
Conducted Emission	FCC Part 15:2018 Subpart B	ANSI C63.4	Pass
Radiated Emission	FCC Part 15:2018 Subpart B	ANSI C63.4	Pass

**Note:** N/A is an abbreviation for Not Applicable.

## 3. Test Equipment Used

Conducted Emission Test					
Equipment	Manufacturer	Model No.	Serial No.	Last Cal.	Cal.Due Date
EMI Test Receiver	Rohde & Schwarz	ESCI	100321	Jul. 13, 2019	Jul. 12, 2020
RF Switching Unit	Compliance Direction Systems Inc	RSU-A4	34403	Jul. 13, 2019	Jul. 12, 2020
AMN	SCHWARZBECK	NNBL 8226-2	8226-2/164	Jul. 13, 2019	Jul. 12, 2020
LISN	Rohde & Schwarz	ENV216	101131	Jul. 13, 2019	Jul. 12, 2020
Radiation Emission Test					
Equipment	Manufacturer	Model No.	Serial No.	Last Cal.	Cal.Due Date
Spectrum Analyzer	Agilent	E4407B	MY45106456	Jul. 13, 2019	Jul. 12, 2020
EMI Test Receiver	Rohde & Schwarz	ESCI	101165	Jul. 13, 2019	Jul. 12, 2020
Bilog Antenna	ETS-LINDGREN	3142E	00117537	Jan. 27, 2019	Jan. 26, 2020
Bilog Antenna	ETS-LINDGREN	3142E	00117542	Jan. 27, 2019	Jan. 26, 2020
Horn Antenna	ETS-LINDGREN	3117	00143207	Mar. 03, 2019	Mar. 02, 2020
Horn Antenna	ETS-LINDGREN	3117	00143209	Mar. 03, 2019	Mar. 02, 2020
Pre-amplifier	HP	11909A	185903	Mar. 04, 2019	Mar. 03, 2020
Pre-amplifier	HP	8449B	3008A00849	Mar. 03, 2019	Mar. 02, 2020
Cable	HUBER+SUHNER	100	SUCOFLEX	Mar. 03, 2019	Mar. 02, 2020
Signal Generator	Rohde & Schwarz	SML03	IKW682-054	Mar. 03, 2019	Mar. 02, 2020
Positioning Controller	ETS-LINDGREN	2090	N/A	N/A	N/A

---

## 4. Label Requirements & Statement Requirements

**Class B Label Requirements**

Class B digital device subject to certification by the FCC shall carry a warning label which includes the following statement:

**\*\*\* WARNING \*\*\***

This device complies with Part 15 of the FCC Rules. Operation is subject to the following two conditions: (1) this device may not cause harmful interference, and (2) this device must accept any interference received, including interference that may cause undesired operation.

**Class A Statement Requirements**

The operator's manual for a Class A digital device shall contain the following statements or their equivalent:

**\*\*\* WARNING \*\*\***

This equipment has been tested and found to comply with the limits for a Class A digital device, pursuant to part 15 of the FCC Rules. These limits are designed to provide reasonable protection against harmful interference when the equipment is operated in a commercial environment. This equipment generates, uses, and can radiate radio frequency energy and, if not installed and used in accordance with the instruction manual, may cause harmful interference to radio communications. Operation of this equipment in a residential area is likely to cause harmful interference in which case the user will be required to correct the interference at his own expense. Notice: The changes or modifications not expressly approved by the party responsible for compliance could void the user's authority to operate the equivalent.

\*\*\*\*\*

If the EUT was tested with special shielded cables the operator's manual for such product shall also contain the following statements or their equivalent: Shielded interface cables and/or AC power cord, if any, must be used in order to comply with the emission limits.



## 5. Conducted Emission Test

### 5.1 Test Standard and Limit

#### 5.1.1 Test Standard

FCC Part 15 B: 2018

#### 5.1.2. Test Limit

**Conducted Emission Test Limit (Class A)**

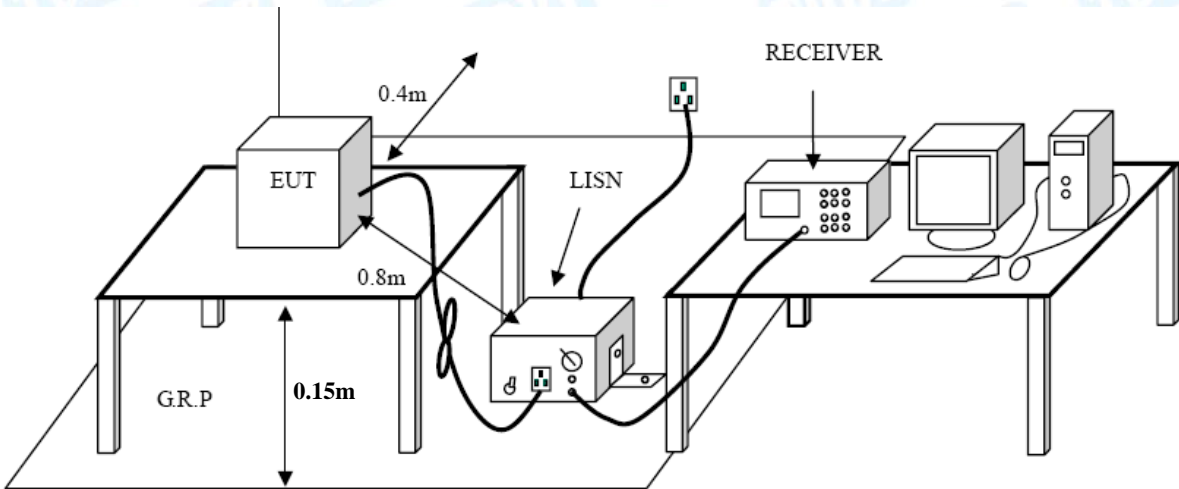
Frequency (MHz)	Maximum RF Line Voltage (dB $\mu$ V)	
	Quasi-peak Level	Average Level
0.15~0.50	79	66
0.50~30	73	60

**Conducted Emission Test Limit (Class B)**

Frequency (MHz)	Maximum RF Line Voltage (dB $\mu$ V)	
	Quasi-peak Level	Average Level
0.15~0.5	66 ~ 56 *	56 ~ 46 *
0.50~5	56	46
5~30	60	50

\*decreasing linearly with logarithm of the frequency

### 5.2 Test Setup



### 5.3 Test Procedure

The EUT was placed 0.15 meters from the horizontal ground plane with EUT being connected to the power mains through a line impedance stabilization network (LISN). All other support equipments powered from additional LISN(s). The LISN provide 50 Ohm/50uH of coupling impedance for the measuring instrument.

The cables shall be insulated (by up to 15 cm) from the horizontal ground reference plane, and shall be folded back and forth in the center forming a bundle 30 to 40 cm long.

I/O cables that are not connected to a peripheral shall be bundled in the center. The end of the cable may be terminated, if required, using the correct terminating impedance. The overall length shall not exceed 1 m.

LISN at least 80 cm from nearest part of EUT chassis.

The bandwidth of EMI test receiver is set at 9kHz, and the test frequency band is from 0.15MHz to 30MHz.

### 5.4 Test Data

Please refer to the Attachment A.

## 6. Radiated Emission Test

### 6.1 Test Standard and Limit

6.1.1 Test Standard  
 FCC Part 15 B: 2018

#### 6.1.2 Test Limit

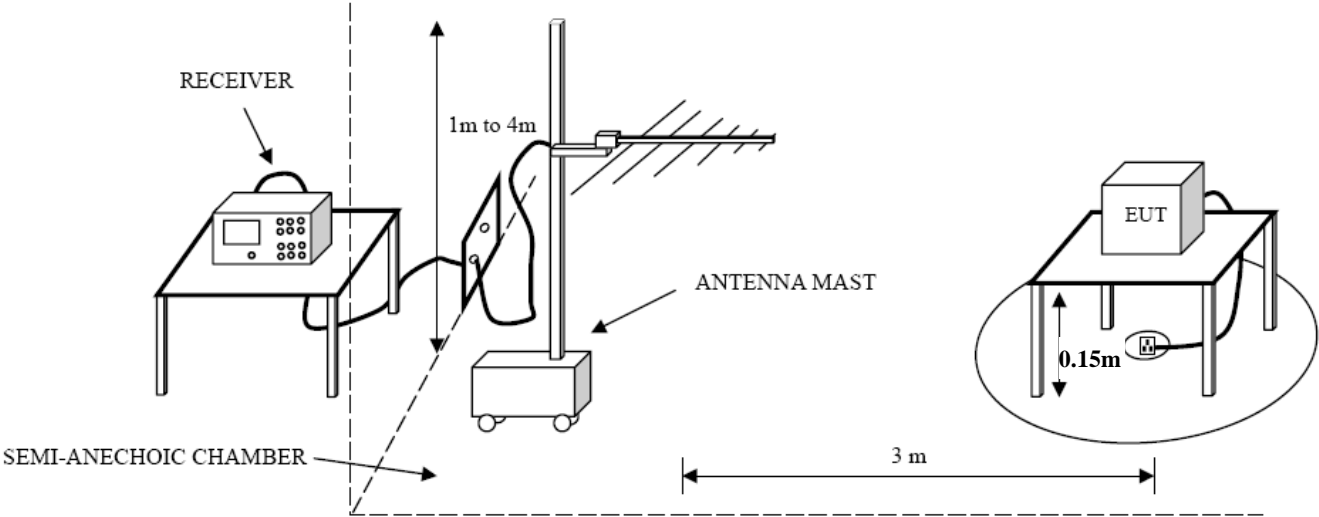
Radiated Emission Test Limit (Class A)	
Frequency MHz	Field Strengths Limits dB(μV/m)
30 ~ 88	49.0
88 ~ 216	53.5
216 ~ 960	56.4
960 ~ 1000	59.5

Radiated Emission Test Limit (Class B)	
Frequency MHz	Field Strengths Limits dB(μV/m)
30 ~ 88	40.0
88 ~ 216	43.5
216 ~ 960	46.0
960 ~ 1000	54.0

\* The lower limit shall apply at the transition frequency.  
 \* The test distance is 3m.

### 6.2 Test Setup



### 6.3 Test Procedure

The EUT was placed on the top of a rotating table which is 0.15 meters above the ground. EUT is set 3.0 meters away from the receiving antenna that mounted on a antenna tower. The table was rotated 360 degrees to determine the position of the highest radiation, the antenna can be moved up and down between 1.0 meter and 4 meters to find out the maximum emission level. Both horizontal and vertical polarizations of the antenna are set to make the measurement.

Measurements shall be made with a quasi-peak measuring receiver in the frequency range 30MHz to 1000MHz. If the Peak Mode measured value compliance with and lower than quasi-peak mode Limit, the EUT shall be deemed to meet QP Limits and then no additional QP Mode measurement performed.

### 6.4 Test Data

Please refer to the Attachment B.

## 7. Photographs - Constructional Details

Photo 1 Appearance of EUT



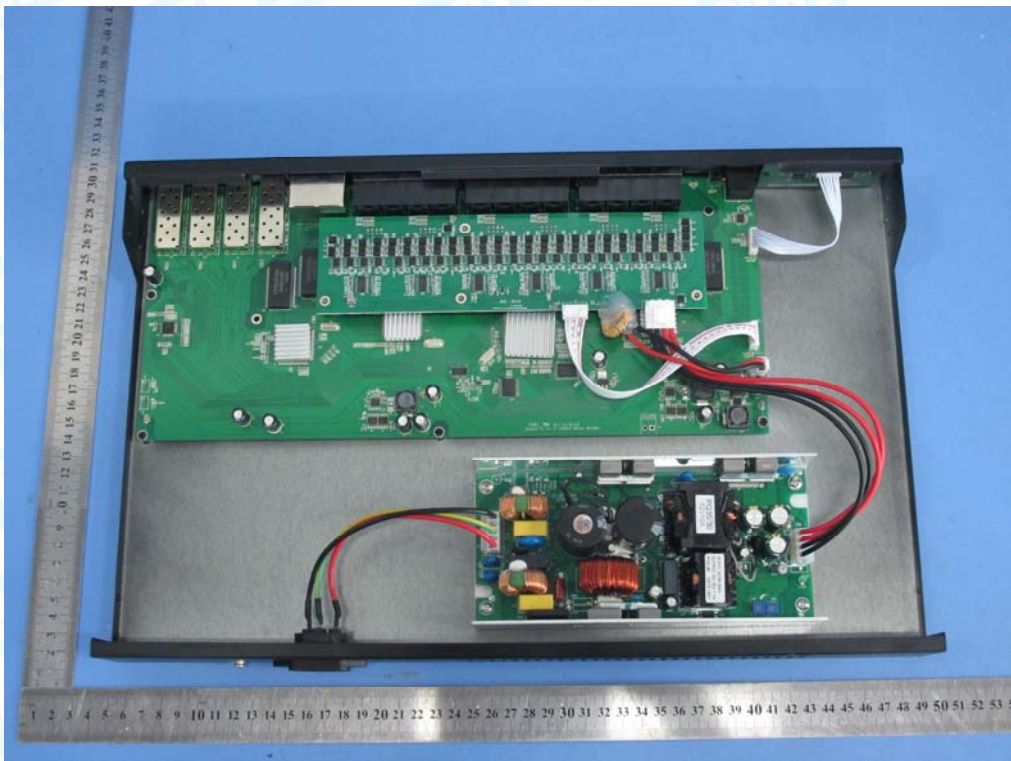
Photo 2 Appearance of EUT



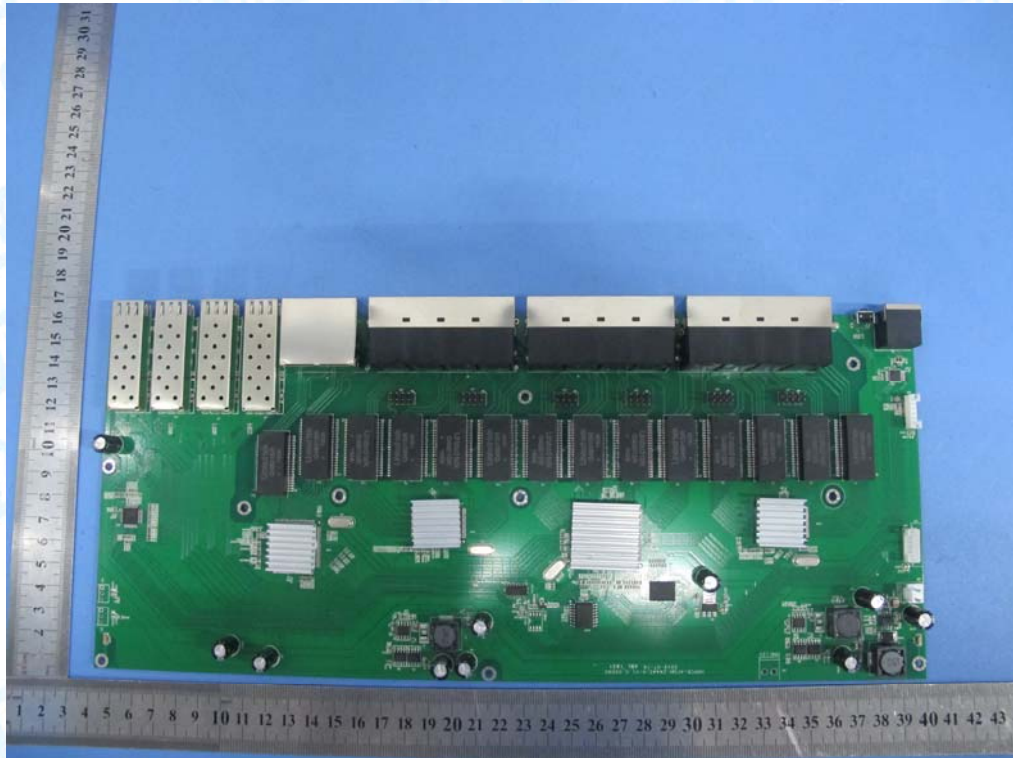
**Photo 3 Appearance of EUT**



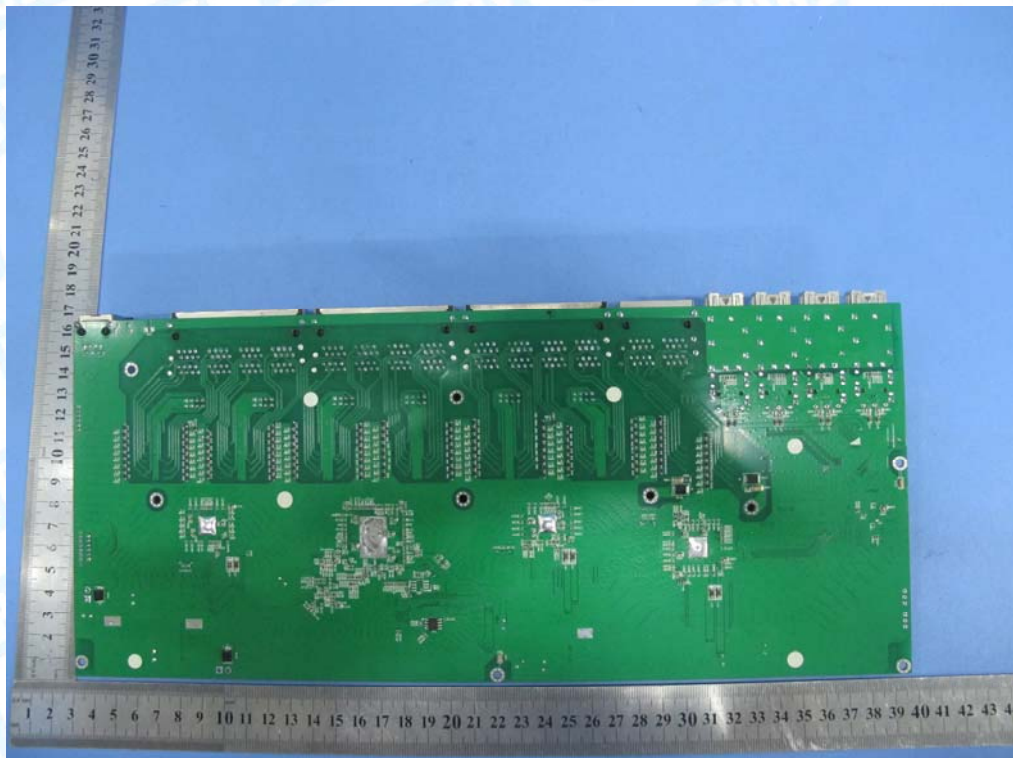
**Photo 4 Internal of EUT**



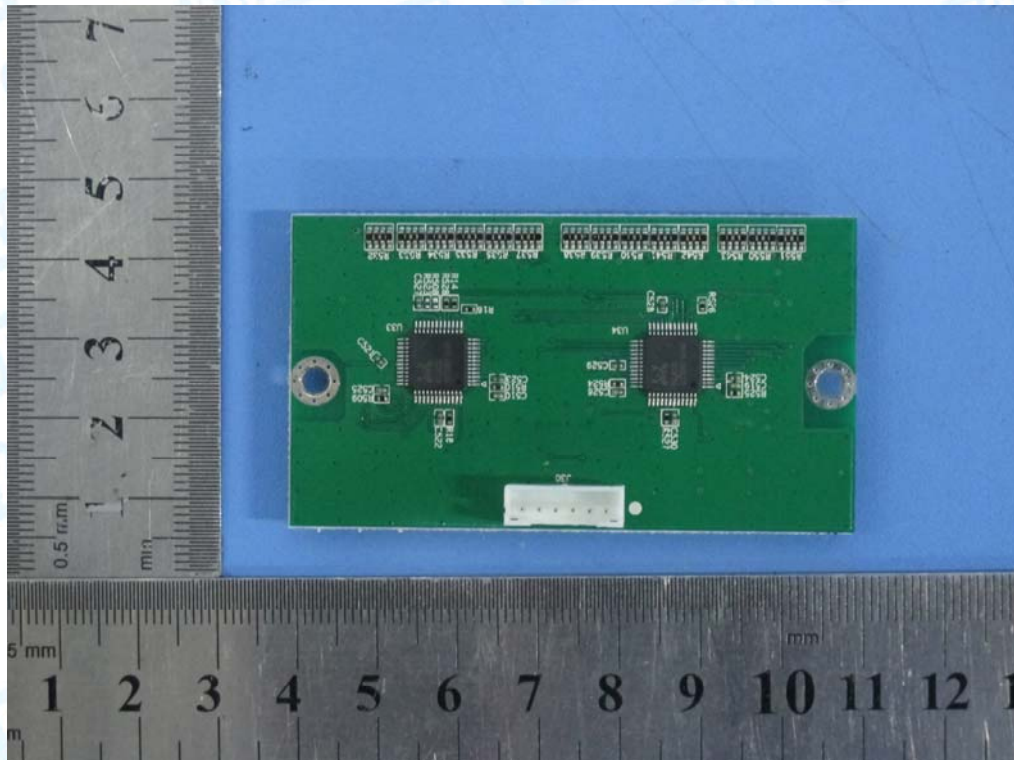
**Photo 5 Appearance of PCB**



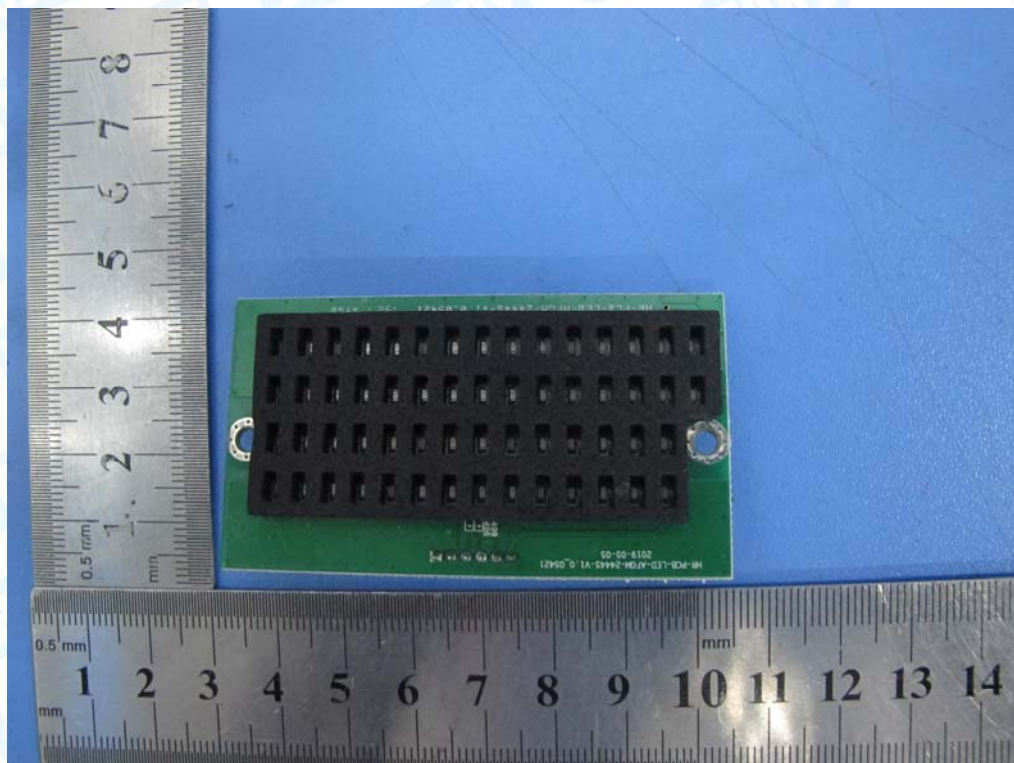
**Photo 6 Appearance of PCB**



**Photo 7 Appearance of PCB**

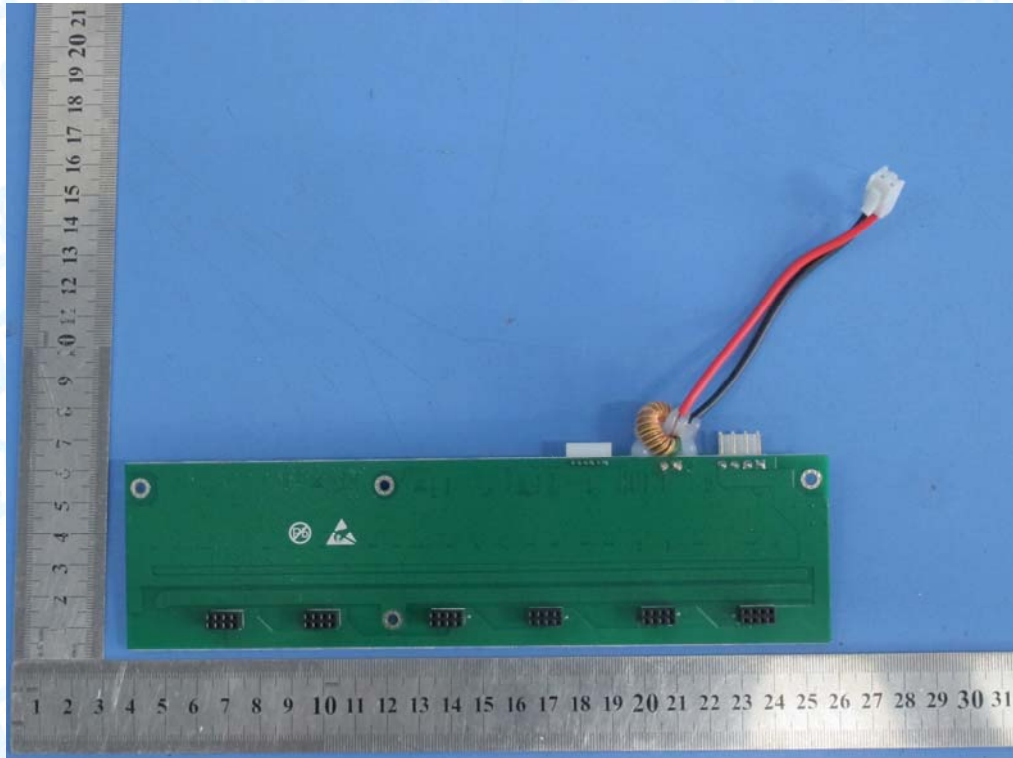


**Photo 8 Appearance of PCB**

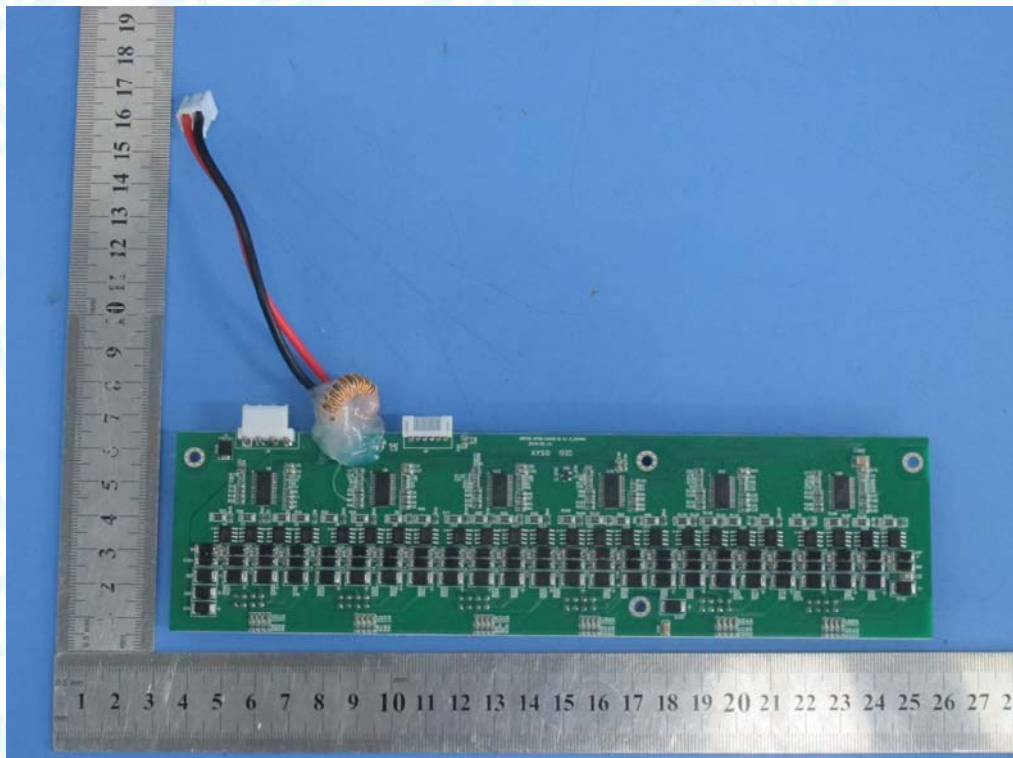




**Photo 9 Appearance of PCB**



**Photo 10 Appearance of PCB**

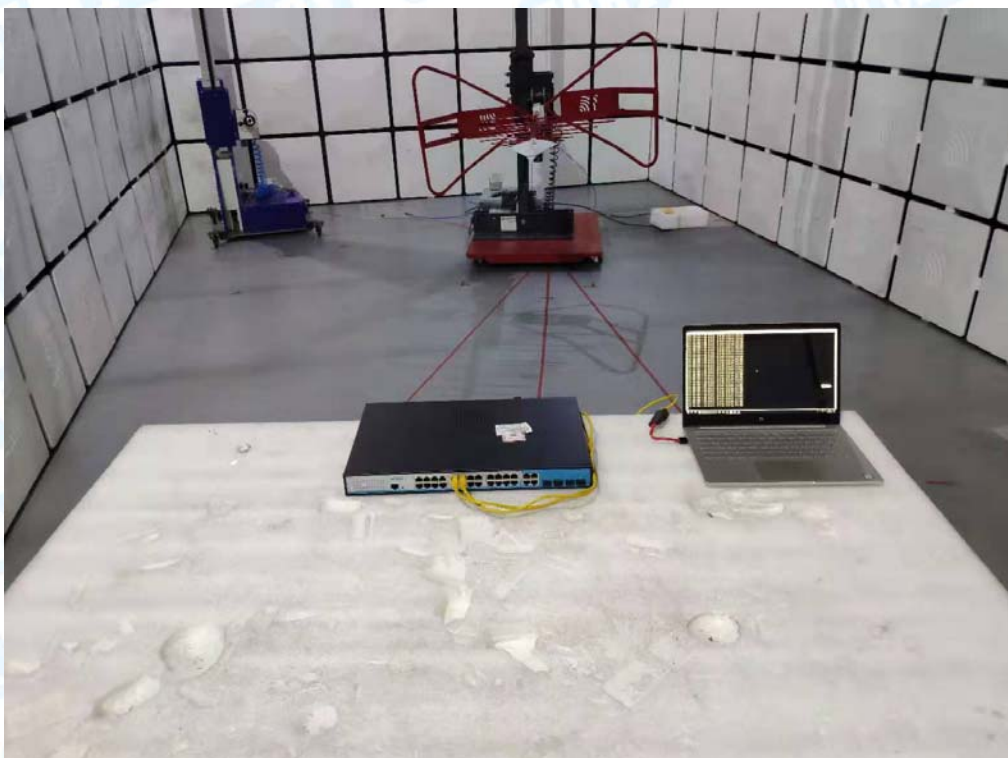


## 8. Photographs - Test Setup

### Conducted Emission Test Setup

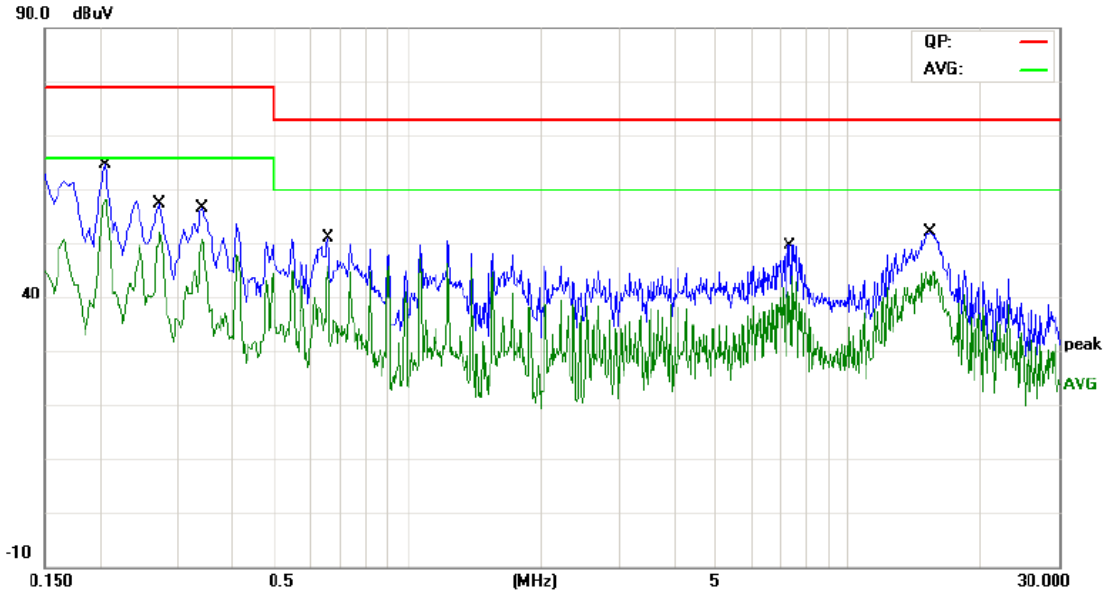


### Radiated Emission Test Setup



### Attachment A--Conducted Emission Data

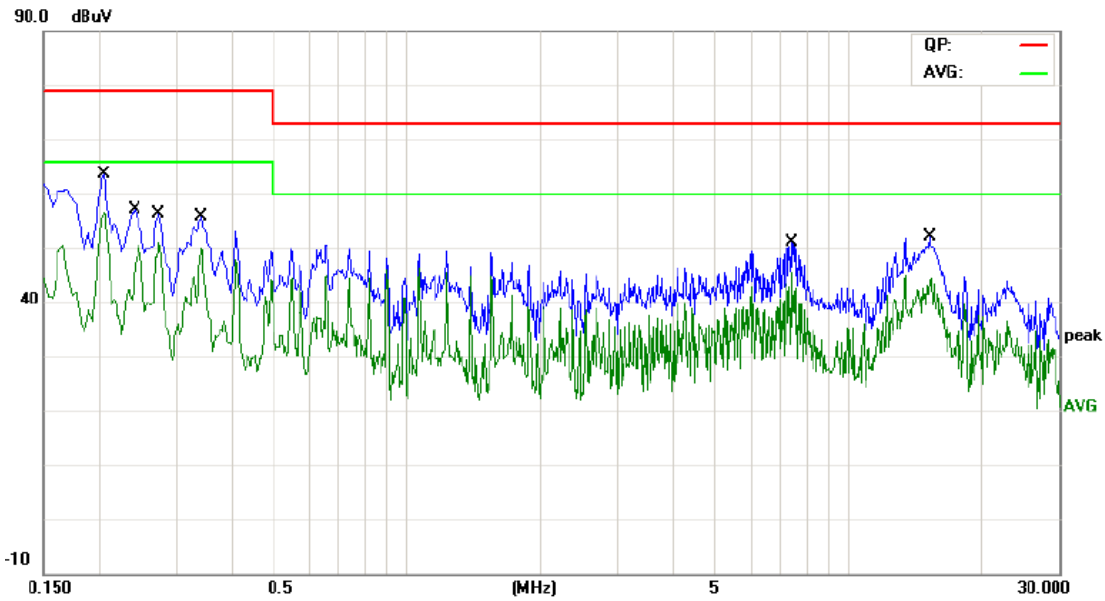
Temperature:	25 °C	Relative Humidity:	55%
Pressure:	1010 hPa		
Test Voltage:	AC 120V/60 Hz		
Terminal:	Line		
Test Mode:	Mode 1		
Remark:			



No.	Mk.	Freq. MHz	Reading Level dBuV	Correct Factor dB	Measure- ment dBuV	Limit dBuV	Over dB	Detector
1		0.2060	52.49	9.78	62.27	79.00	-16.73	QP
2	*	0.2060	47.02	9.78	56.80	66.00	-9.20	AVG
3		0.2740	45.74	9.82	55.56	79.00	-23.44	QP
4		0.2740	41.89	9.82	51.71	66.00	-14.29	AVG
5		0.3420	44.70	9.83	54.53	79.00	-24.47	QP
6		0.3420	40.92	9.83	50.75	66.00	-15.25	AVG
7		0.6580	37.92	9.87	47.79	73.00	-25.21	QP
8		0.6580	35.29	9.87	45.16	60.00	-14.84	AVG
9		7.3620	34.67	9.82	44.49	73.00	-28.51	QP
10		7.3620	28.10	9.82	37.92	60.00	-22.08	AVG
11		15.3380	31.51	9.82	41.33	73.00	-31.67	QP
12		15.3380	23.89	9.82	33.71	60.00	-26.29	AVG

Emission Level= Read Level+ Correct Factor

<b>Temperature:</b>	25 °C	<b>Relative Humidity:</b>	55%
<b>Pressure:</b>	1010 hPa		
<b>Test Voltage:</b>	AC 120V/60 Hz		
<b>Terminal:</b>	Neutral		
<b>Test Mode:</b>	Mode 1		
<b>Remark:</b>			

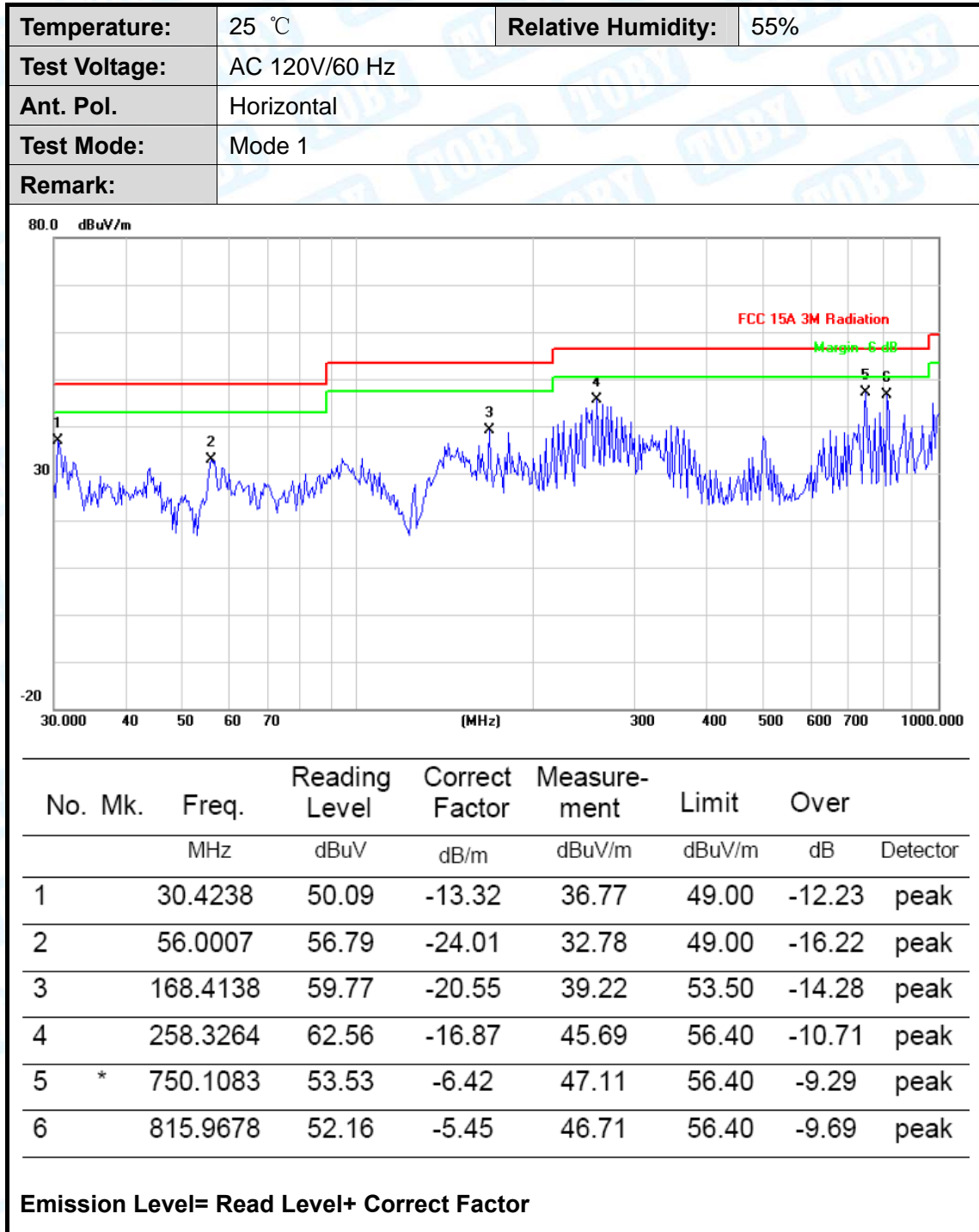


No.	Mk.	Freq. MHz	Reading Level dBuV	Correct Factor dB	Measure- ment dBuV	Limit dBuV	Over dB	Detector
1		0.2060	51.86	9.58	61.44	79.00	-17.56	QP
2	*	0.2060	46.09	9.58	55.67	66.00	-10.33	AVG
3		0.2420	41.59	9.67	51.26	79.00	-27.74	QP
4		0.2420	36.98	9.67	46.65	66.00	-19.35	AVG
5		0.2740	44.34	9.69	54.03	79.00	-24.97	QP
6		0.2740	40.48	9.69	50.17	66.00	-15.83	AVG
7		0.3420	43.18	9.73	52.91	79.00	-26.09	QP
8		0.3420	39.32	9.73	49.05	66.00	-16.95	AVG
9		7.4260	36.65	9.86	46.51	73.00	-26.49	QP
10		7.4260	29.85	9.86	39.71	60.00	-20.29	AVG
11		15.2540	39.62	9.85	49.47	73.00	-23.53	QP
12		15.2540	33.16	9.85	43.01	60.00	-16.99	AVG

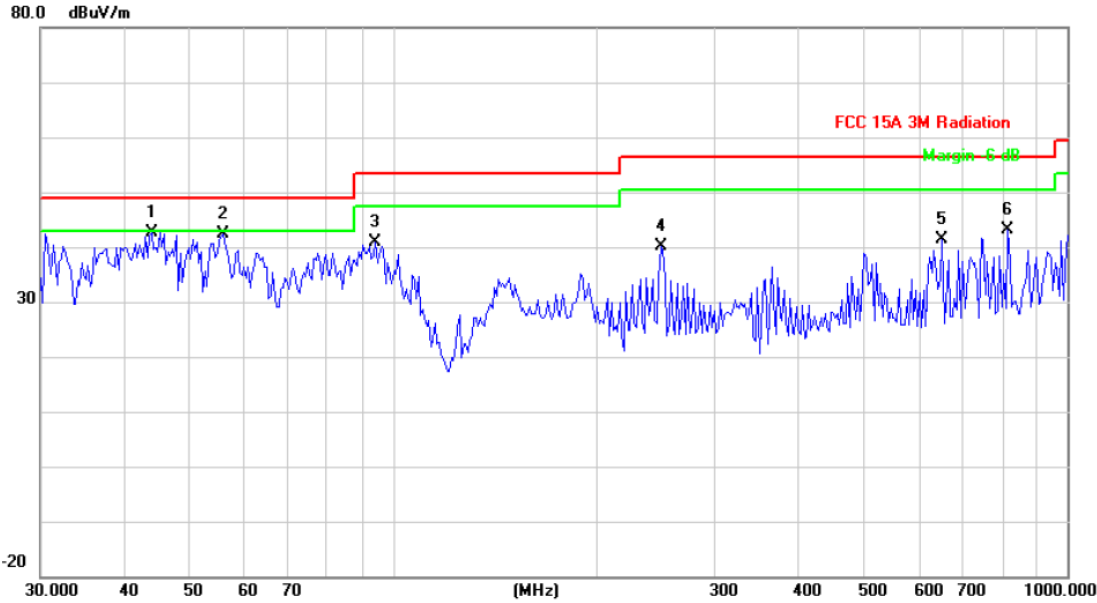
**Emission Level= Read Level+ Correct Factor**

## Attachment B--Radiated Emission Test Data

----Below 1G



<b>Temperature:</b>	25 °C	<b>Relative Humidity:</b>	55%
<b>Test Voltage:</b>	AC 120V/60 Hz		
<b>Ant. Pol.</b>	Vertical		
<b>Test Mode:</b>	Mode 1		
<b>Remark:</b>			



No.	Mk.	Freq. MHz	Reading Level dBuV	Correct Factor dB/m	Measure- ment dBuV/m	Limit dBuV/m	Over dB	Detector
1	*	43.8119	63.72	-21.07	42.65	49.00	-6.35	peak
2		56.0007	66.49	-24.01	42.48	49.00	-6.52	peak
3		94.0979	62.83	-22.06	40.77	53.50	-12.73	peak
4		249.4250	57.10	-17.08	40.02	56.40	-16.38	peak
5		651.9417	49.14	-7.79	41.35	56.40	-15.05	peak
6		815.9678	48.47	-5.45	43.02	56.40	-13.38	peak

Emission Level= Read Level+ Correct Factor

-----END OF REPORT-----